

Product information

Cerniera Bandella

THE
KNOW-
HOW
FACTORY

ZIMMER GROUP

Am Glockenloch 2
77866 Rheinau / Germany

T +49 7844 9110-0

F +49 7844 9110-6199

info@daempfungssysteme.de

www.zimmer-group.com

General Data:

Type of product:	Soft-Close fitting for food shelves
Origin:	Rheinau, Baden-Württemberg, Germany
Lifetime:	250.000 Cycles for main opening (0°-93°) 5.000 Cycles for emergency opening (93°-180°)
Installation Option:	Food shelves Hinges

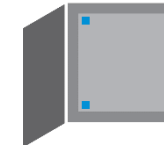
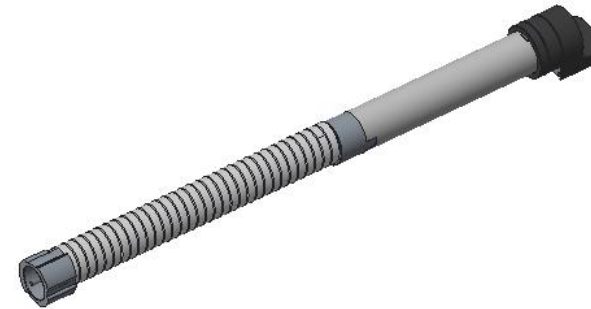

Complete Mechanism. High Lifetime. Improved Performance.

This unit enables windows and door leaves made of a wide variety of materials to be closed automatically and softly.

The mechanics are inconspicuous and space-saving in the hinge. The opening angle can be up to 180 degrees. There is also a locking option in the open state.

This product was developed for food shelves, Convenience Shop for example, for baked goods or for refrigerated products. Due to CO2 reduction, cooling systems will have to be equipped with doors in the coming years. Due to Corona-requirements, food, for example baked goods must be protected by a door.

Index

- 1. **Content**..... 3
- 2. Function..... 3
- 3. Technical data..... 4
- 4. Characteristic..... 4
- 5. Integration..... 5
- 6. Accessory..... 7
- 7. Drawing..... 8
- 8. Materials..... 10

1. Content

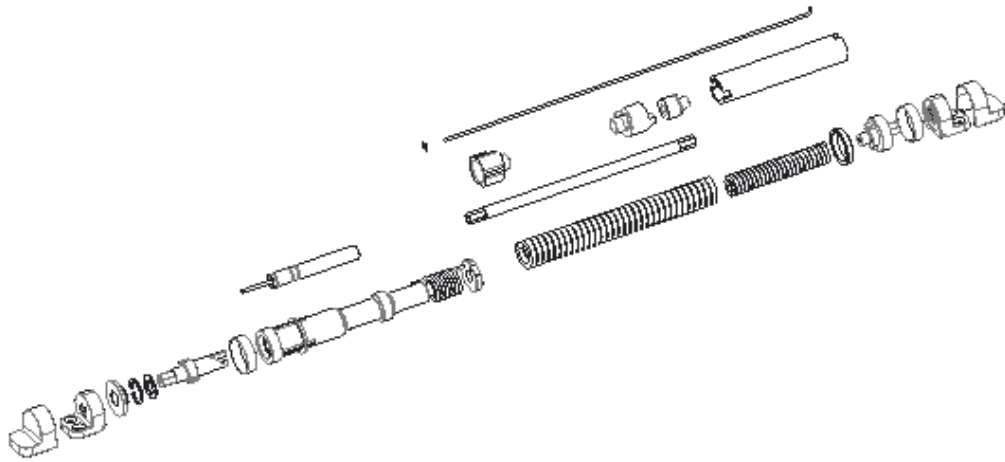

2. Function

- Door closes softly and automatically
- Main operation from 0° to 93°
- Emergency opening from 93° to 180°
- Inclination angle $0-10^{\circ}$



3. Technical data

Housing length [mm]:	> 467
Housing diameter [mm]:	25,6
Piston rod diameter [mm]:	3,0
Stroke [mm]:	14
Return spring	yes
Maximum weight to be braked [kg]:	7,5
Lifetime [cycles]:	250.000/5.000
Operating conditions [°C]	10 to 40
Storage conditions [°C]	-20 to 80

4. Characteristic

Closed unit	<input checked="" type="checkbox"/>
Fluid damper	<input checked="" type="checkbox"/>
Air-friction damper	
Damping effect one-way	<input checked="" type="checkbox"/>
Damping effect both-sided	
Different locking hooks possible	
Emergency function	<input checked="" type="checkbox"/>

5. Integration

Food Shelves	<input checked="" type="checkbox"/>
Sliding door	
Drawer	
Hinge	<input checked="" type="checkbox"/>
Flap	

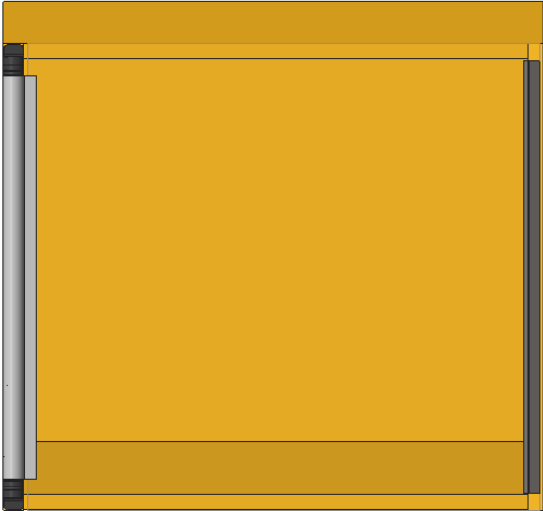
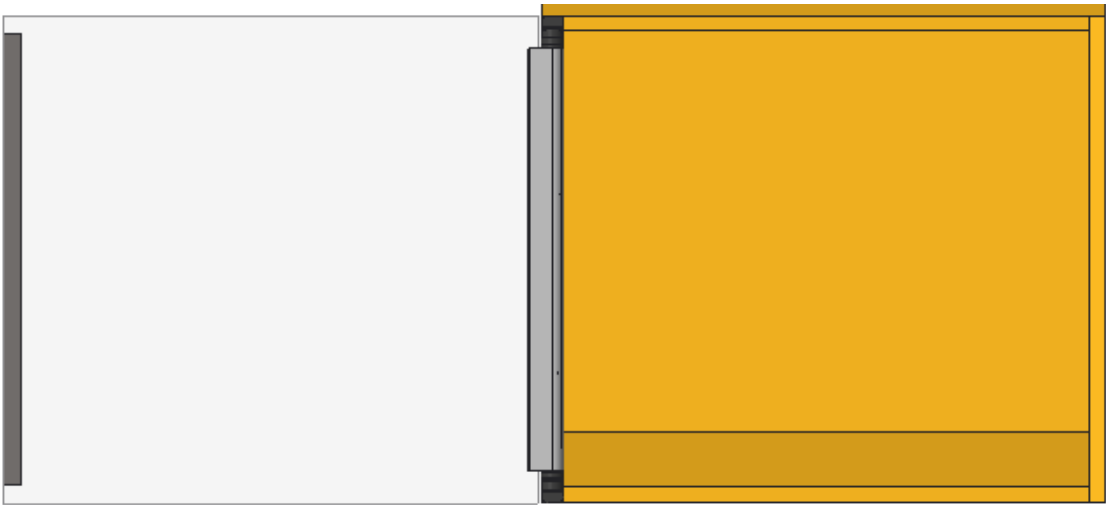
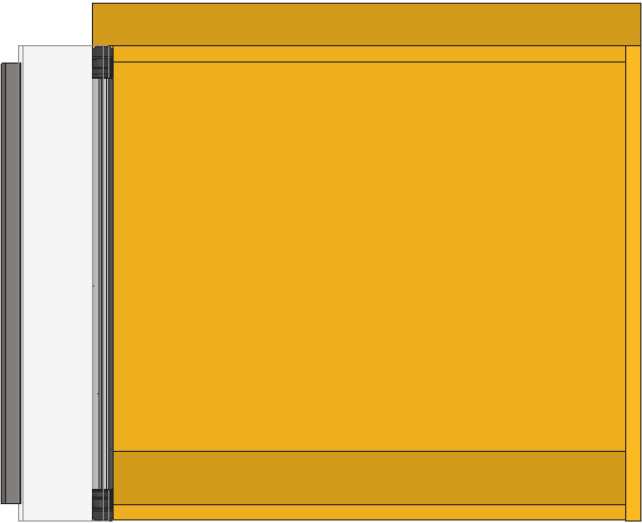



baked goods



frozen goods

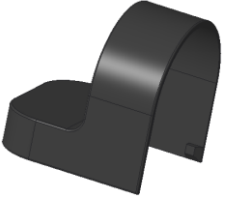
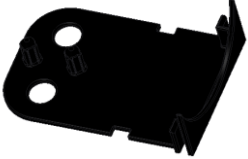
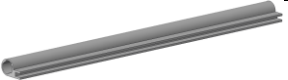

6. Accessory

	Cover (different colors possible)
	Cover (different colors possible)
	Tube

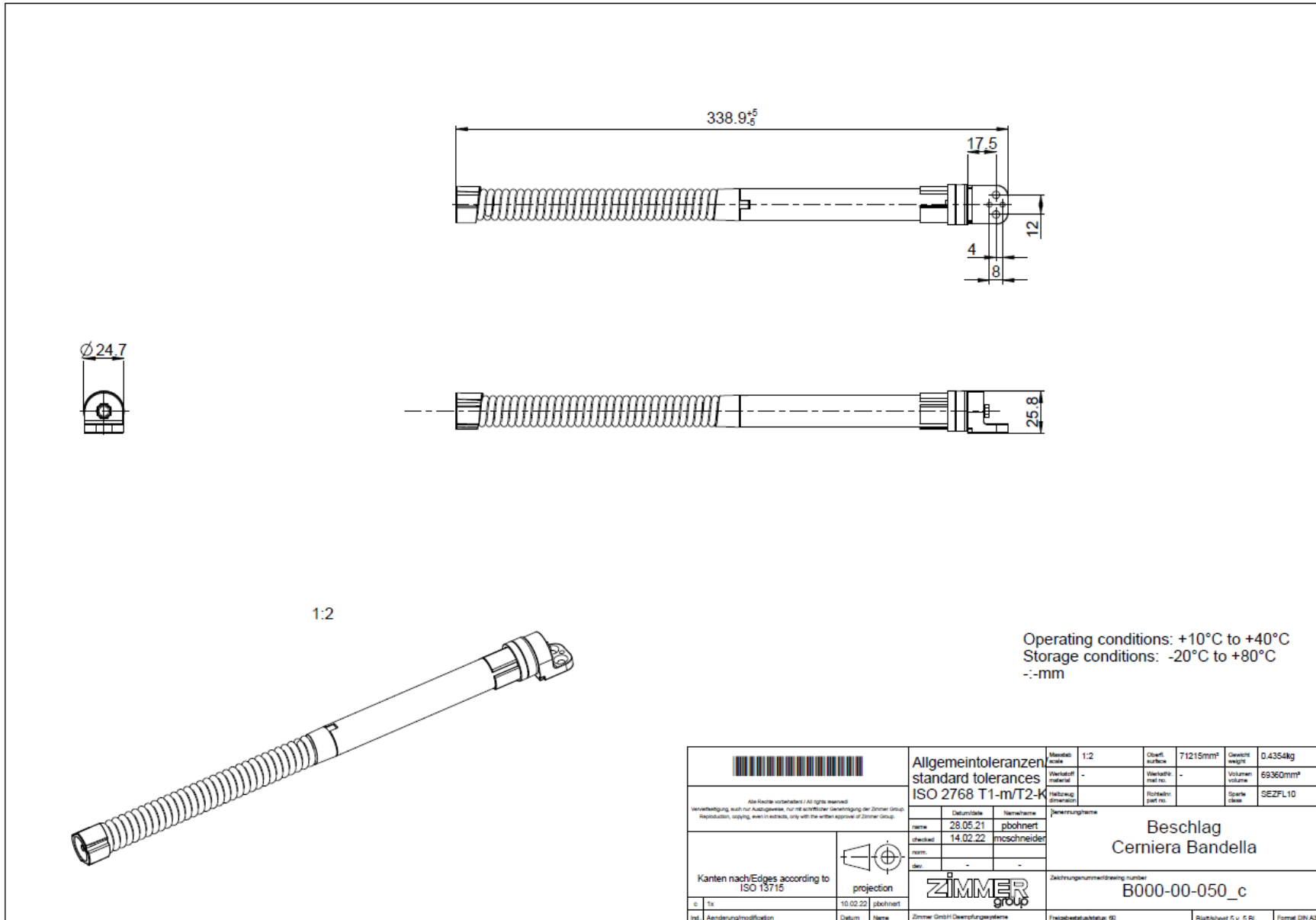

7. Drawing

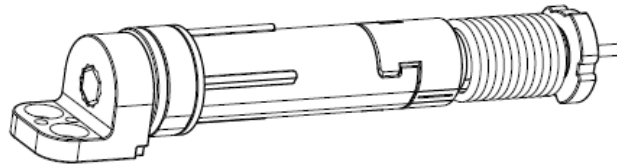
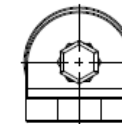
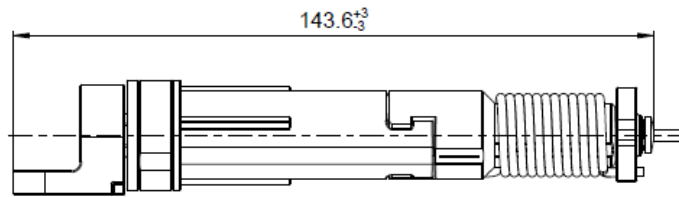
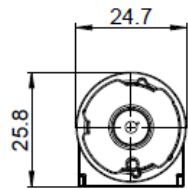
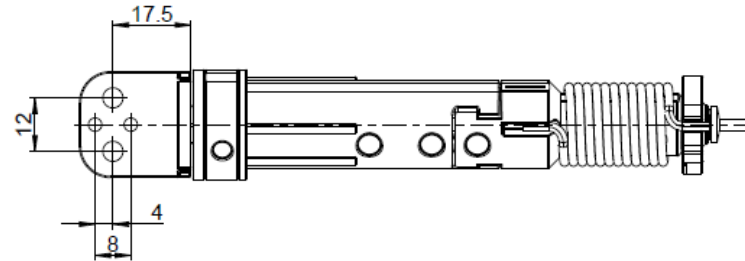

		Allgemeintoleranzen standard tolerances ISO 2768 T1-m/T2-K		Maßstab Scale	1:2	Oberfl. surface	71215mm ²	Gewicht weight	0.4354kg
<small>Alle Rechte vorbehalten / All rights reserved Verarbeitung, auch nur Auszugweise, nur mit schriftlicher Genehmigung der Zimmer Group Reproduction, copying, even in extracts, only with the written approval of Zimmer Group.</small>		Herstellf. material	-	Vierhahlf. thread	-	Volumen volume	69360mm ³		
		Herstellg. dimension		Richtmaß part no.		Spalte class	SEZFL10		
		Datum/date	28.05.21	Name/name	pbohnert	Zerlegungstitel Exploded view title			
		name	28.05.21	checked	14.02.22	Beschlag Cerniera Bandella			
		dev.	-						
		norm.	-						
		proj.	-						
Kanten nach/Edges according to ISO 13715		 projection				Zeichnungsnummer/drawing number B000-00-050_c			
Gr. size	Tx	10.02.22	plachart	Zimmer GmbH Dampfungsgeräte		Freigeblattdaten/40		Blatt/Sheet 5 v. 5 Bl.	Format DIN A3
Änderung/modification		Datum	Name	Zimmer GmbH Dampfungsgeräte		Freigeblattdaten/40		Blatt/Sheet 5 v. 5 Bl.	Format DIN A3



Operating conditions: +10°C to +40°C
Storage conditions: -20°C to +80°C
-:-mm

		Allgemeintoleranzen/ standard tolerances ISO 2768 T1-m/T2-K		Maßstab scale	1:1	Oberfl. surface	33999mm ²	Gewicht weight	0.2368kg
<small>Alle Rechte vorbehalten / All rights reserved Verarbeitung, auch nur Auszugweise, nur mit schriftlicher Genehmigung der Zimmer Group Reproduction, copying, even in extracts, only with the written approval of Zimmer Group</small>		name	15.06.21	pbohnert	Verstärk. material	-	Volumen volume	36628mm ³	
Kanten nach/Edges according to ISO 13715		checked	15.11.21	jzschmann	Halbzug dimension		Fläche part no.	Spez. class	BESCHLAGKlap
 projection		norm.	-	-	Zeichnungsnummer/drawing number B014-10-004_a				
q	2x	05.11.21	pbohnert						
inst.	Aenderung/modification	Datum	Name	Zimmer GmbH Dampfungssysteme	Freigeber/Lackstatus: 00	Blatt/Sheet	5 v. 5 Bl.	Format	DN A3

8. Materials

Housing:	Aluminium
Spring:	EN10270-1-DH